



# WS500 ALTERNATOR REGULATOR PRODUCT MANUAL



Thank you for purchasing the Wakespeed® WS500 Advanced Alternator Regulator. The WS500 provides unexcelled control over alternator-based charging by utilizing system voltage, current monitoring and alternator and battery temperature to ensure the safest and most powerful charging possible.

This Quick Start Guide is intended to provide the installer and user with the basic information required to ensure that the WS500 is properly connected and configured to deliver optimal charging performance in most applications.

This guide will provide instructions to configure the regulator to provide intelligent charge control for a variety of battery types and battery capacities. In addition to its onboard DIP switch controls, the WS500 can be connected to a PC via a built in USB terminal to access a broad range of advanced configuration options. These advanced configuration controls are discussed in the WS500 Communications and Programming Guide.

---

## CONTENTS

Safety Considerations . . . . .	02
Configuring for Alternator Polarity . . . . .	02
Locating and Mounting Regulator . . . . .	03
Wiring Harness Installation . . . . .	03 - 06
Programming with DIP Switches . . . . .	07 - 08
Connecting to CAN Enabled System . . . . .	08
LED Status and Advisory Codes . . . . .	09 - 11
Warranty Information . . . . .	11

## SAFETY CONSIDERATIONS

The WS500 Alternator Regulator is part of a complex electrical system. A trained and licensed automotive or marine electrician is strongly recommended for its installation. Please note that an improperly installed electrical system components can result in severe damage to property and serious personal injury. Failure to properly install the WS500 Alternator Regulator, its wiring, and improper configuration may void the regulator's warranty in addition to damaging other system components. Wakespeed® is not liable for damage or injury resulting from improperly installed, configured, or modified applications of its charge control products. The following safety precautions are recommended:

- Electrical and mechanical system installation or repair should NEVER be attempted when fatigued or while using alcohol or medication that can impair judgement or motor skills
- Ensure that all jewelry and loose clothing is removed prior to work around engine or mechanical equipment.
- Use the proper tool for the job being done.
- Turn off switches and disconnect your batteries prior to installing your WS500 Alternator Regulator or other electrical system components. Failure to do so may cause damage or injury.
- Ensure that your alternator is designed to be used with an external voltage regulator. Determine whether the alternator is designed for positive (p-type) or negative (n-type) field excitation and be sure that the regulator's wiring harness is compatible for the alternator type.
- Read the manual!
- If you are not with charging system installation and operation, please consider leaving the job to a licensed and experienced technician.

---

## CONFIGURING FOR ALTERNATOR POLARITY

The WS500 Alternator Regulator is designed for use with any positively or negatively excited alternator that's configured for external voltage regulation. The regulator's field output polarity is determined by the wiring harness used. If your alternator is equipped for positive (A-type) regulation, the WS500 should be equipped with the WS500/PH wiring harness. If the alternator is designed for negative (B-type) field excitation, the WS500/NH wiring harness should be used.

While many aftermarket alternators are designed for external regulation, most factory-installed alternators are equipped with single-stage internal regulators. In most cases, the alternator can be modified to support external regulation, which requires disabling the internal regulator and diode trio, and ensuring that one of the alternator's brushes is connected to the alternator's ground connection and the alternator's other brush can be connected to the external regulator's field wire. If you are unsure of your alternator's polarity or regulation, please consult with an electrical service shop.

## LOCATING AND MOUNTING REGULATOR



Housed in a durable PC/ABS blend resin, the WS500 is designed to meet water resistance standards. Although the enclosure and external wiring connections are waterproof in design, we do recommend finding a mounting location for the regulator that is well protected from excessive moisture or exposure to extreme high or low temperatures. The regulator's footprint is approximately 7-1/2" x 4-3/4" (190mm x 120mm) and is designed for mounting on a bulkhead or other flat surface.

Four 3/16" diameter holes located on the flanges at each end of the regulator are provided for mounting. If the regulator is installed in an engine compartment or other location where exposure to moisture may occur, mount the regulator with the terminal connectors facing downward to provide protection from water intrusion.

The WS500 features a waterproof LED indicator light that provides a range of operational codes. If monitoring is desired, consider placing the regulator where the bezel can be easily seen. For more information, see the LED Display Codes section in this guide.

---

## WIRING HARNESS INSTALLATION

The WS500 utilizes a high quality, industrial grade Ampseal connector system to provide a waterproof pairing between the regulator and wiring harness, along with sealed RJ45 connectors for CAN bus system connection. Matching p-type (WS500/PH) or n-type (WS500/NH) harnesses are ordered separately, depending on the field polarity of the alternator being used.

Wiring harnesses are 60" long, and feature three wiring legs sheathed in expandable braid covering. One leg of the harness provides wires which are typically connected at the alternator, and include wires for alternator positive (power), alternator negative (ground), field, and stator (AC/tach output). A built-in alternator temperature sensor cable is built into the alternator wiring leg. The second wiring leg is directed to the battery bank, and includes positive and negative voltage sense wires, positive and negative current sense wires for connection to a shunt, and a 2-wire cable with a Superseal-type connector for use with an optional battery temperature sensor (WS500/BT-K).

The third leg of the wiring harness carries three wires which typically are connected at the panel; an ignition wire which connects to the ignition switch or other switched voltage source, the lamp wire, which provides a signal for a warning lamp and the function-in wire which can be used to initiate small engine mode and other custom functions.



## WIRING HARNESS INSTALLATION (CONTINUED)

Once the regulator has been mounted in an appropriate location, the wiring harness can be connected. Two tabs on the wiring plug must be aligned with the slots on the harness connector. The harness connector will click into place when properly inserted.

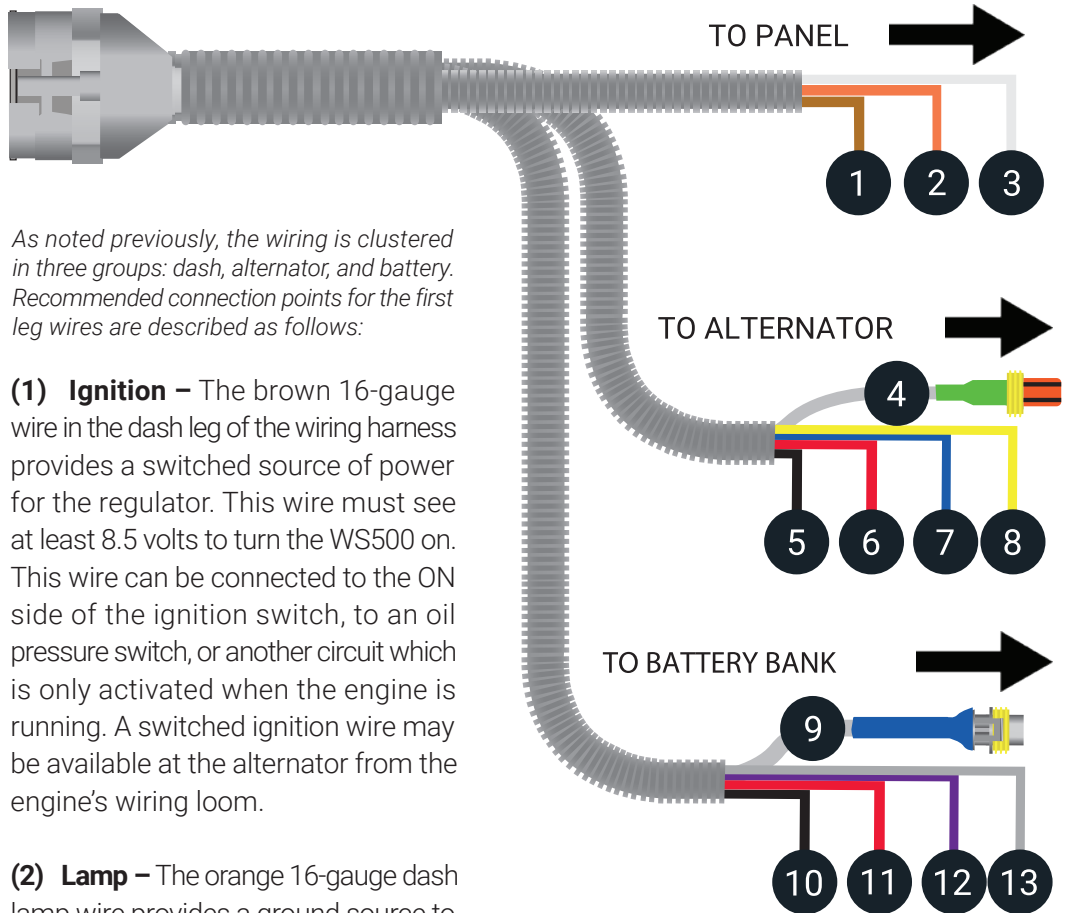

As noted previously, the wiring is clustered in three groups: dash, alternator, and battery. Recommended connection points for the first leg wires are described as follows:

**(1) Ignition** – The brown 16-gauge wire in the dash leg of the wiring harness provides a switched source of power for the regulator. This wire must see at least 8.5 volts to turn the WS500 on. This wire can be connected to the ON side of the ignition switch, to an oil pressure switch, or another circuit which is only activated when the engine is running. A switched ignition wire may be available at the alternator from the engine's wiring loom.

**(2) Lamp** – The orange 16-gauge dash lamp wire provides a ground source to create a complete circuit at a warning light or audible alarm if an alarm condition is active. See Error/Alarm codes for a list of activating conditions.

**(3) Function In** – The white 16-gauge Function In can be configured to provide a number of custom controls which can be activated by connecting the wire to >8.5VDC+ via a toggle or other ON/OFF type switch. In default mode, the Function In mode will enable equalize mode when the regulator is configured for lead acid batteries. When the WS500 is configured for LiFePO<sub>4</sub> batteries (see DIP switch instructions), Function In will force the system to float.

## WIRING HARNESS INSTALLATION (CONTINUED)

*The second leg of the wiring harness provides the necessary connection points at the alternator being controlled by the WS500. Recommended connection points for the wires are described as follows:*

**(4) Alternator Temperature Sensor** – The grey two-conductor cable includes a temperature sensor embedded in a tinned battery lug. The alternator temperature sensor enables the WS500 to reduce field output if the ambient temperature at the alternator exceeds a set temperature. This protects the alternator and reduces losses of efficiency under extended loads. The alternator temperature sensor should be mounted on a rear case bolt or on one of the alternator's ground terminal bolts. This sensor is not connected electrically to the alternator.

**(5) Alternator Negative** – The black 16-gauge alternator negative (ground) wire must be connected at the alternator's ground terminal. If the alternator case provides connection to system ground, connect the black wire to the alternator's mounting bolt. Be sure that the terminal connector provides a clean connection to bare metal that's free of paint, corrosion or other materials that could affect a solid continuity to ground.

**(6) Alternator Positive** – The red 16-gauge alternator positive (power) wire provides the source of positive voltage required to operate the WS500 alternator regulator. This wire should be connected directly to the positive output post of the alternator. The power wire should be fused at 10 amps, or 15 amps on an extra large case alternator. An ATC fuse in a sealed holder is recommended.

**(7) Field** – The blue 16-gauge field wire carries field current from the regulator to the alternator. Polarity will vary based on the alternator or wiring harness being used.

**(8) Stator (AC Tap)** – The yellow 16-gauge stator wire provides a source signal from the alternator, indicating the speed of rotation. This wire can be connected directly to the alternator's stator (AC) output, or can be spliced into the alternator's tach output.

*The third leg of the wiring harness provides the necessary connection points to monitor voltage and current at the battery bank being charged. Recommended connection points for the wires are described as follows:*

**(9) Battery Temperature Sensor Terminal** – The grey two-conductor cable is terminated with a Superseal-type connector which mates with the optional Battery Temperature Sensor Kit (WS500/BT-K). When used in conjunction with the optional battery temperature sensor, this cable enables the regulator to determine the ambient temperature of the batteries, and modify charging voltage for batteries above or below the standard value of 25°C. Should the value detected at the battery exceed 52°C, the regulator will discontinue charging.

## WIRING HARNESS INSTALLATION (CONTINUED)

**(10) Negative Battery Sense** – The black with yellow tracer, 16-gauge negative wire must be connected to the negative post of the battery being charged. In multiple battery banks, the sense wire should be located at the same post as the cable connected to ship's ground.

**(11) Positive Battery Sense** – The red with yellow tracer, 16-gauge positive wire must be connected to the charge side of the fuse inline on the positive cable near the battery, or on the positive post of the battery if no fuse is present. The positive sense wire is connected directly to a "hot" source, and should be fused at 3 amps. An ATC fuse in a sealed holder is recommended.

**(12) Current Sense High** – The purple 16-gauge wire connects to the "high" side of a current shunt. The default current shunt rating is 500A/50mV.

**(13) Current Sense Low** – The grey 16-gauge wire connects to the "low" side of a current shunt. The default current shunt rating is 500A/50mV.

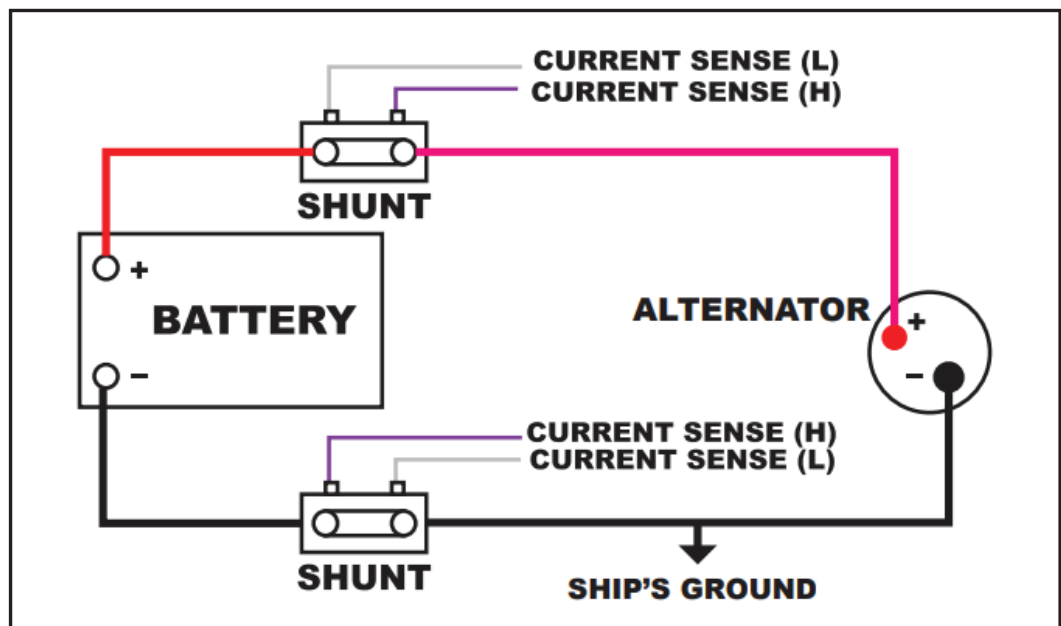

*NOTE: DIAGRAM IS INTENDED TO INDICATE PLACEMENT OF CURRENT SENSE WIRES BASED ON SHUNT LOCATION. ONLY ONE SHUNT IS REQUIRED FOR REGULATOR OPERATION.*

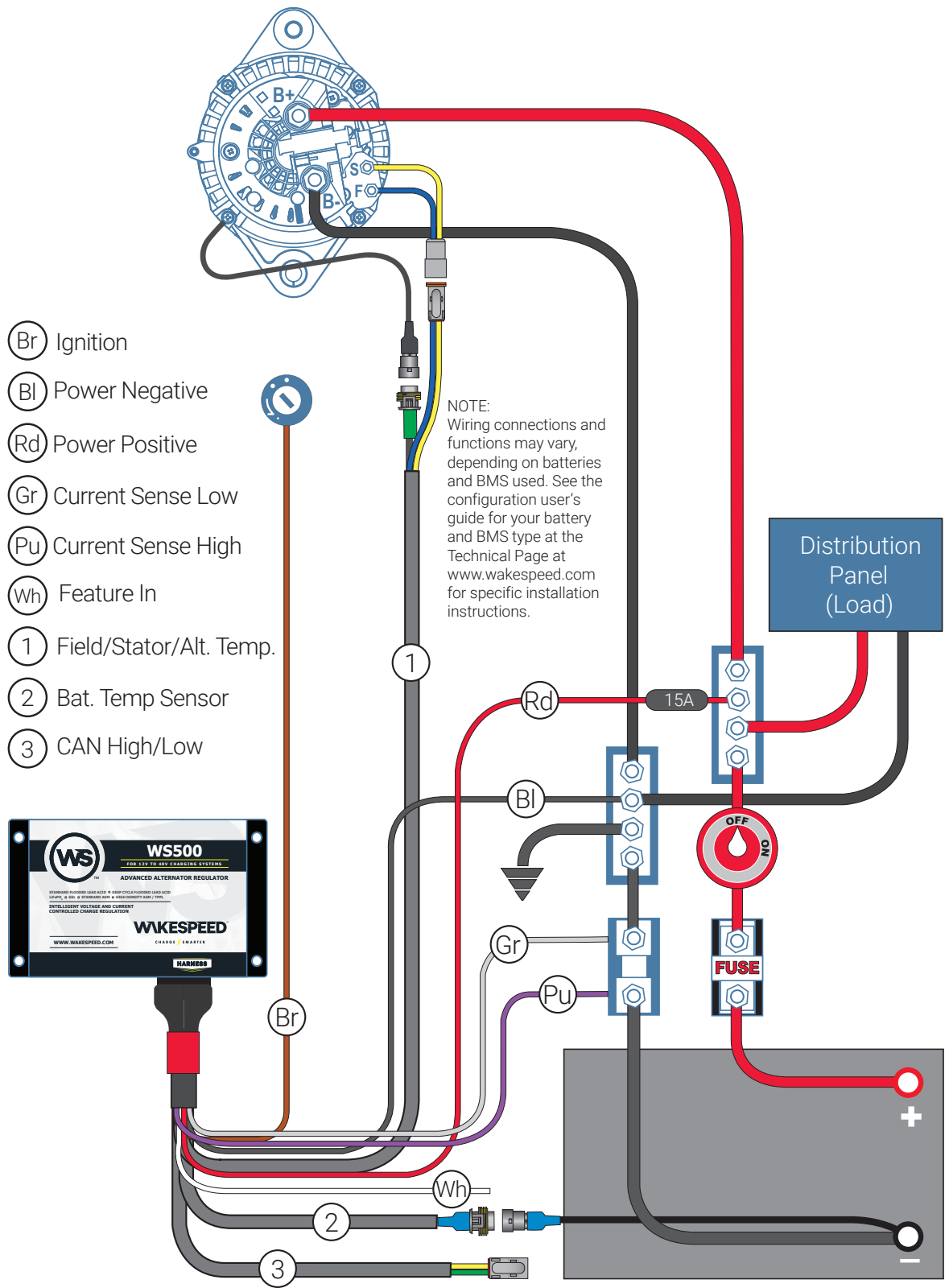



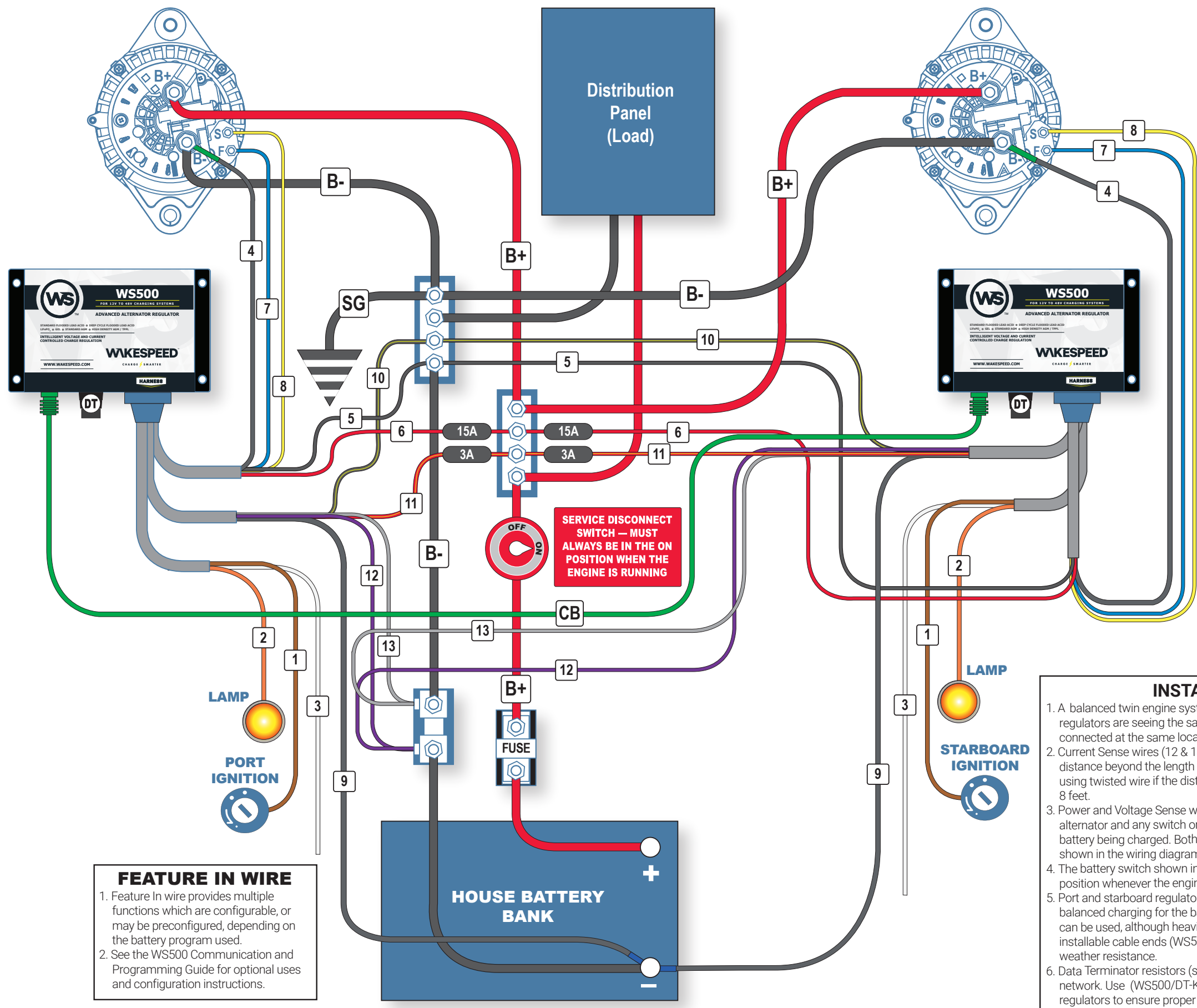

- 1 IGNITION WIRE (Black)
- 2 LAMP WIRE (Orange)
- 3 FEATURE IN WIRE (White)
- 4 ALTERNATOR TEMPERATURE SENSE
- 5 POWER NEGATIVE WIRE (Black)
- 6 POWER POSITIVE WIRE (Red)
- 7 ALTERNATOR FIELD WIRE (Blue)
- 8 ALTERNATOR STATOR WIRE (Yellow)
- 9 BATTERY TEMPERATURE SENSE
- 10 VOLTAGE SENSE - WIRE (Black/Yellow)
- 11 VOLTAGE SENSE + WIRE (Red/Yellow)
- 12 CURRENT SENSE + WIRE (Purple)
- 13 CURRENT SENSE - WIRE (Grey)
- CB CANBUS CABLE
- DT DATA TERMINATOR
- B+ POSITIVE BATTERY CABLE
- B- BATTERY GROUND CABLE
- SG SYSTEM GROUND

**FEATURE IN WIRE**

1. Feature In wire provides multiple functions which are configurable, or may be preconfigured, depending on the battery program used.
2. See the WS500 Communication and Programming Guide for optional uses and configuration instructions.

**INSTALLATION NOTES**

1. A balanced twin engine system installation requires that both port and starboard regulators are seeing the same information. Note that wire #'s 5, 6, 10 and 11 are connected at the same locations within the system.
2. Current Sense wires (12 & 13) can pick up RF noise if extended a substantial distance beyond the length of the wiring harness. Noise can be mitigated by using twisted wire if the distance between either regulator and the shunt exceeds 8 feet.
3. Power and Voltage Sense wires (6 & 11) must be connected between the alternator and any switch or fuse which could disconnect the alternator from the battery being charged. Both Power and Voltage Sense wires must be fused as shown in the wiring diagram.
4. The battery switch shown in the positive battery cable MUST be in the ON position whenever the engine is running.
5. Port and starboard regulators must be connected via CANbus to provide balanced charging for the batteries being charged. Standard CAT5 or CAT6 cable can be used, although heavier-duty underground cable is preferred. Our field installable cable ends (WS500-RJ45FI) provide additional strain relief and weather resistance.
6. Data Terminator resistors (sold separately) are required at both ends of a CAN network. Use (WS500/DT-K) terminators in the unused RJ45 jacks on both regulators to ensure proper network termination.



# PROGRAMMING WITH DIP SWITCHES

Mounted on the circuit board inside the WS500 regulator's enclosure is an eight-position DIP switch panel. These switches can be configured to select a battery ID when used in a CAN connected system, to select the charging profile based on the battery technology being charged, and to define the capacity of the battery bank being charged. In addition, the regulator can be configured to a small alternator mode, which limits the maximum field potential to 75 percent. This can be used when battery capacity exceeds the alternator's capabilities, or to protect smaller engines and belts from excessive alternator loads.

## SELECTING BATTERY ID

When used as part of a CAN enabled system, the WS500 alternator regulator can monitor data from a Battery Management System (BMS) and utilize that data to control charging. In order to properly discern the information it's provided, the WS500 must recognize the source of the data. The first two DIP switches enable the regulator to identify the battery being charged. Four selections are available via the #1 and #2 DIP switches.

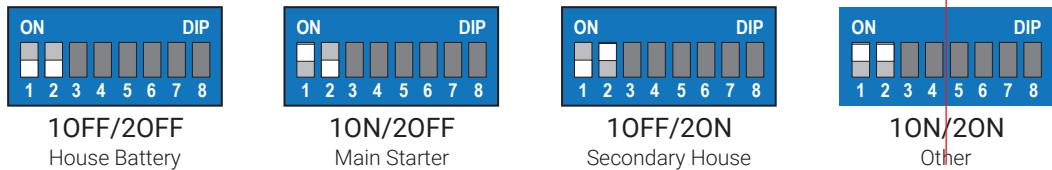

## SELECTING CHARGE PROFILES

The WS500 provides eight charge profiles (detailed on the regulator data page) which can be selected by using the #3, #4 and #5 DIP switches — including two customizable profiles which can be configured on a PC via the regulator's USB port (which is also mounted on the circuit board). One of the two customizable profiles is preset for LiFePO<sub>4</sub> batteries. DIP switch settings are shown below.

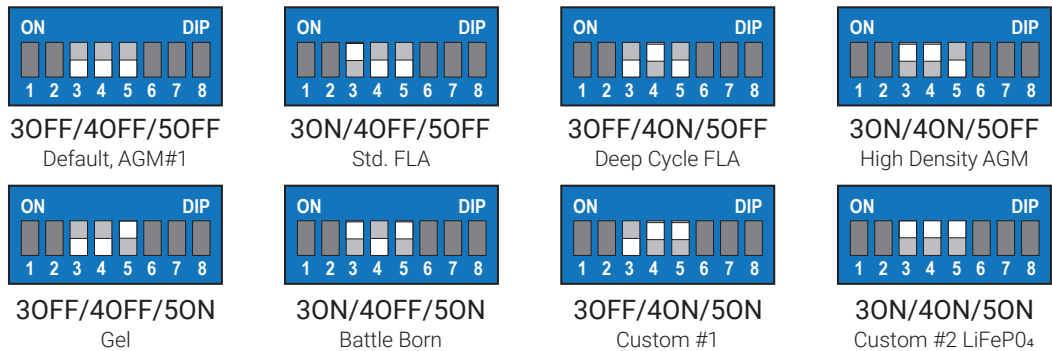

## DEFINING BATTERY CAPACITY

Charging attributes may change based on the size of the battery bank being charged. To ensure optimal charging, the regulator provides the ability to configure charge control to meet the capacity of the batteries being charged. Four selections are available, using the #6 and #7 DIP switches.

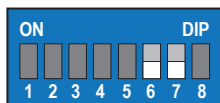

**6OFF/7OFF**  
< 250Ah

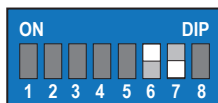

**6ON/7OFF**  
250Ah-500Ah

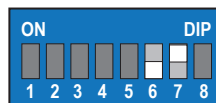

**6OFF/7ON**  
500Ah - 750Ah

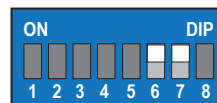

**6ON/7ON**  
> 750Ah

## SMALL ALTERNATOR

The #8 DIP switch enable the user to place a 75 percent limit on field output. This feature can be used to reduce demand on an overloaded alternator, or to protect a small engine and belt if alternator capacity exceeds their capabilities.



**8 OFF**  
Large Alternator Mode

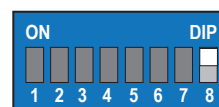

**8 ON**  
Small Alternator Mode

---

## CONNECTING TO A CAN ENABLED SYSTEM

Wakespeed® WS500 is the only alternator regulator currently available that provides J1939 CAN connection based on multiple data languages, including RV/C, CiA 303, and OSEnergy data standards. OSEnergy (Open Systems Energy) is an architectural specification which provides a framework for the design, deployment, and operation of charging sources associated with a DC battery. Allowing them to work together in a 'systems' approach while meeting the full requirements of an associated battery as well as concurrently supplying house power needs in a consistent and efficient way. You can learn more at <https://github.com/OSEnergy/OSEnergy>.



Access to CAN is provided via two RJ45 connectors on the exterior of the regulator. Note that CAN systems are chained and that unused connection points will require the use of a terminator.







For details about setting up and utilizing the WS500's CAN capabilities, download the Wakespeed Communications and Programming Guide at [www.wakespeed.com](http://www.wakespeed.com).

## LED STATUS AND ADVISORY CODES

The WS500 Alternator Regulator is equipped with a bright, multi-color LED which provides a range of operational and advisory codes. The LED is visible via a waterproof bezel located on near the lower left corner of the label on the regulator's cover. There are three modes of information provided: Standard Operation, indicated by a green flashing pattern; Error/Advisory mode, indicated by a flashing red pattern; and Sync mode, indicated by a flashing orange/yellow pattern.

### STANDARD OPERATION MODE (GREEN FLASHING LED)

During normal operations, the WS500 will display one of five status messages, indicating the regulator's operational status. Message codes are as follows:

<b>IDLE</b>		<i>Short Flash/Long Delay (4 sec.)</i>
<b>RAMP TO BULK</b>		<i>Short Flash/Short Delay (1/4 sec.)</i>
<b>ACCEPTANCE</b>		<i>Flash/Flash/Long Delay (2 sec.)</i>
<b>OVER CHARGE</b>		<i>Equal Flash/Delay (1/4 sec.)</i>
<b>FLOAT/POST FLOAT</b>		<i>Equal Long Flash/Delay (2 sec.)</i>
<b>EQUALIZE</b>		<i>Short Flash/Flash/Long Delay (1.5 sec.)</i>

### ERROR/ADVISORY MODE (RED FLASHING LED)

Should the WS500 determine that a condition is outside of normal limits, it will display a red flashing LED pattern, followed by a series of flashes indicating the type of fault occurring. Most errors are hard-faults, indicating a condition which the WS500 Alternator Regulator is unable to decipher and as such will shut down until corrected, in order to prevent any potential systems or battery damage. A few errors will attempt to auto-restart to see if the failing condition clears (example, error low battery voltage). When a fault is detected, the WS500 will flash the "Error" code twice, followed by a series of flashes indicating the fault/error number. Note: the LED will only indicate the most recent fault detected.

Error code information provided here reflects the most commonly-found regulator or system faults. The Wakespeed WS500 Programming and Communications Guide provides more in depth information about error/advisory issues, and will be updated as needed, to reflect new or revised error messages. Entry into error/advisory mode is indicated as shown below:

<b>ERROR*</b>		<i>Equal Long Flash/Delay (4 sec.)</i>
<b>RESTARTING</b>		<i>Equal Flash/Delay (1/4 sec.)</i>

## ERROR/ADVISORY CODES (INDICATED BY RED FLASHING LED)

As noted previously, error/advisory codes may reflect a fault at the regulator, or a more universal system fault. Some faults may result with an auto-restart by the regulator (such as low system voltage). Other faults may cause the regulator to freeze up until the condition is corrected. Note: the error/advisory code will flash the first digit of the code, then the last digit of the code, with a short space in between. In other words, a Code 23 would be shown as two red flashes, space, three red flashes. If the code you see is not listed here, refer to the WS500 Programming and Communications Guide.

Error Code	Description
12	Battery temperature exceeded limit
13	Battery voltage exceeded upper limit
14	Battery voltage below lower limit
21	Alternator temperature exceeded limit
22	Alternator rpms above expected value
23	Alternator #2 temperature exceeded limit
24	Alternator temperature exceeded limit during ramp
31	Global Variable charging state has some unsupported value in check_for_faults
32	Global Variable charging state has some unsupported value in manage_alt
33	Global Variable cpIndex has some unsupported value in calculate_alt_targets
34	Global Variable cpIndex has some unsupported value in check_for_faults
35	Global Variable SystemAmpMult has some unsupported value in check_for_faults
41	Internal Field FET temperature exceed limit.
42	A 'Required' sensor is missing, and WS500 is configured to FAULT out
51	A CAN message was received that the battery charging bus has been disconnected
52	We have noted that a command has been sent asking for the battery bus to be disconnected
53	Battery Instance number is out of range (needs to be from 1..100)

## **SYNC MODE (INDICATED BY ORANGE FLASHING LED)**

In applications where the WS500 is taking commands from a BMS or from another WS500 alternator regulator, such as a twin engine application, where two alternators are being used to charge the same battery bank, the WS500 may be placed in a sync (or slave) mode, where its operation is being guided by another device. When the regulator defers to another in this mode, it will indicate that it acting as a slave by flashing yellowish orange on the LED.

---

## **WAKESPEED WARRANTY**

Wakespeed® warrants the original purchaser the product is free from any defects in material or workmanship for a period of two years from the original date of purchase. If any such defect is discovered within the warranty period, Wakespeed will repair or replace the product free of charge, subject to verification of the defect or malfunction upon delivery or shipping prepaid to Wakespeed.

Defects or physical damage resulting from abuse, neglect, accident, improper repair, alteration, modification, or unreasonable use of the products are not covered under warranty. Returned products showing evidence of tampering and/or unapproved access to internal components will not be supported under warranty.

Wakespeed cannot warranty Broken cases, parts damaged by fire, water, freezing, collision, theft, explosion, rust, corrosion, damaged cables or wiring harnesses, or items damaged in shipment in route to Wakespeed Warranty Services for repair. Wakespeed assumes no responsibility for consequential damage or loss or expense arising from these products or any labor required for service or repair.

Wakespeed will not repair or be held responsible for any product sent without proper identification and return address or Return Authorization number clearly marked on the package. You must include proof of date and place of purchase (photocopy of purchase invoice) or we cannot be responsible for repairs or replacement. In order to expedite warranty claims, Wakespeed requires that a Return Authorization is completed prior to returning a defective product for repair.

If factory service is required, contact Wakespeed Warranty Service at 360-299-1231, Monday through Friday, 8:30 AM to 3:30 PM, (PST). Repair or replacement of the defective part or product is to be supplied free of charge upon delivery of the defective product to Wakespeed Warranty Service. Customer is responsible for all return transportation charges and any air, international or rush delivery expense.

PRESET CHARGING PROFILES									
Charge Mode	Default/AGM #1	Standard FLA	Deep Cycle FLA	High Density AGM	Gel	BattleBorn	Custom #1	Custom #2	
Delay Time (Sec.)	30 Sec.								
<b>Bulk/Absorption</b> — Bulk Phase is typically when the largest amount of energy is placed into the battery. By following up with a current tapering Acceptance phase, batteries may be safely and full charged.									
	Target Voltage	14.1	14.8	14.6	14.7	14.1	14.2	14.4	13.8
	Exit Current	3%	1%	1%	0.6%	1%	5%	3%	3%
	Maximum Time Before Exit	6 Hrs.	3 Hrs.	4.5 Hrs.	4.5 Hrs.	6 Hrs.	30 Mins.	6 Hrs.	1 Hr.
<b>Overcharge</b> — Some battery manufactures follow the Acceptance Phase by a low-current Overcharge or Finish phase. This is to in effect 'polish off' the final charge in a safe and controlled manner.									
	Current Limit	Not Applicable	Not Applicable	Not Applicable	Not Applicable	Not Applicable	3%	1%	Not Applicable
	Exit Voltage						14.4	15.30	
	Maximum Time Before Exit						30 Mins.	3 hrs	
<b>Float</b> — Once a battery has been charged to its target SOC, Float is used to allow the Alternator to supply energy for ongoing loads while preserving th battery's charge. If a large load is placed on the system, a ew recharge cycle may occur.									
	Target Voltage	13.4	13.5	13.2	13.4	13.5	13.4	13.1	13.36
	Exit Current	-2%	-2%	-2%	-2%	-2%	-10%	-2%	0%
	Exit Voltage	12.8	12.8	12.8	12.8	12.8	13.0	12.8	12.9
<b>Post Float</b> — In some deployments it is desired to fully turn off charging once the battery has reached its SOC goal. Post Float allows for this complete turnoff, while still monitoring for conditions which would warrant a new charge cycle.									
	Target Voltage	Not Applicable	Not Applicable	Not Applicable	Not Applicable	Not Applicable	Not Applicable	Not Applicable	Not Applicable
	Exit Current								
	Maximum Time Before Exit								
<b>Equalization</b> — Periodically batteries may want to have a maintenance charge applied, typical to provide some type for cell to cell balancing. For charge profiles 1.7, Equalize mode may be enabled via the Feature-in port, while for charge profile #8 it may only be activated by \$FRM:E									
	Target Voltage	Not Applicable	Not Applicable	15.3	Not Applicable	Not Applicable	Not Applicable	15.3	14.6
	Current Limit			5%				3%	
	Exit Current			n/a				1.8%	
	Max Time Before Exit			3 Hrs.				1 Hr.	
Low Voltage Alarm	8v								
High Voltage Alarm	16.5v (18v if in Equalize mode)								
Battery Temperature Compensation (Per deg C)	-24mV	-30mV	-30mV	-24mV	-30mV	n/aMin	-30mV	n/a	
Min Charge Temp	-45c	-45c	-45c	-45c	-45c	5c	-45c	0c	
Max Charge Temp	45c	45c	45c	45c	45c	45c	45c	40c	

\*This table is applicable for WS500 Firmware ver 2.5.0 and above.